



**Murat Avcı, Adem Yılmaz**

Batman University, Batman-Turkey  
muratsarya@gmail.com; adem.yilmaz@batman.edu.tr

DOI	<a href="http://dx.doi.org/10.12739/NWSA.2019.14.3.1A0435">http://dx.doi.org/10.12739/NWSA.2019.14.3.1A0435</a>	
ORCID ID	0000-0002-9207-2807	0000-0001-7266-0866
CORRESPONDING AUTHOR	Adem Yılmaz	

## INCREASING EFFICIENCY BY INTEGRATING THERMOELECTRIC MATERIALS INTO FUEL CELL

### ABSTRACT

PEM (Polymer Membrane Fuel Cell) is a technology that emits electricity from the chemical reaction of hydrogen and oxygen gases. The material is also capable of generating electricity due to the temperature difference applied to both surfaces. In this study, it is aimed to establish a mechanism to evaluate the waste heat produced by the fuel cell by using peltier. The fuel cell is designed to facilitate heat transfer to the Thermoelectric Coolant. One side of the Thermoelectric Coolant was mounted on the heat exit surface of the fuel cell and a fan was used to remove heat from the other surface. As a result of the experiments, it was seen that the most efficient working range of PEM fuel cell was limited to 70-80°C, thus the surface temperature difference required for the efficient operation of the peltier was not fully formed. However, it has been determined that the energy obtained from the PEM fuel cell can be increased by 10% in these conditions.

**Keywords:** Thermoelectric Coolant, Fuel Cell, Cooling Fan, Polymer Electrolyte Membrane, Peltier

### 1. INTRODUCTION

Energy is a resource which mankind needs more day by day and applies various methods to achieve. Electrical energy is undoubtedly one of the most commonly used forms of energy. We make use of electrical energy to make our lives easier in many areas of our lives. Around 12 billion TEP (tons of equivalent petroleum) of energy is produced in the world every year [1]. A majority of this amount is acquired from fossil fuels or nuclear power plants. The tendency to adopt their individual own lifestyles each passing day also leads people to produce their own energy. Thus, in what ways can a person produce electricity to meet his or her needs? Although PV systems and wind turbines are the main ways, fuel cells and thermoelectric materials are considered as alternative ways. In this study, we aimed to create a system that will recover the heat generated by the thermoelectric material as well as the electrical energy generated by chemical energy as a result of the work of the fuel cell. In this way, we will increase the amount of energy to be obtained by evaluating both the energy generated by the fuel cell as well as the waste heat thrown out. We decided to work with Proton Conversion Membrane (PEM) fuel cell as it is the most widely used, easy to find, and inexpensive. The fuel cell combines hydrogen and oxygen from the air as a result of various reactions to produce water, electricity and heat. This heat should be removed from the surfaces by means of fans or different coolants since high temperatures of the fuel cell adversely affect its operation. The PEM fuel cell structure consists

#### How to Cite:

Avcı, M. and Yılmaz, A., (2019). Increasing Efficiency by Integrating Thermoelectric Materials into Fuel Cell, **Engineering Sciences (NWSAENS)**, 14(3):104-111, DOI: 10.12739/NWSA.2019.14.3.1A0435.

of anode, cathode, electrolyte layer and gas channel current collectors as shown in Figure 1. H<sub>2</sub> and O<sub>2</sub> fuels pass through the gas channels and reach the anode and cathode, respectively. Reactive gases reach the proton-permeable membrane after passing through the diffusion layer. In the anode section, H<sub>2</sub> fuel is catalyzed and separated into protons and electrons. Hydrogen protons pass through the polymer electrolyte membrane and react with oxygen in the cathode section to form water.

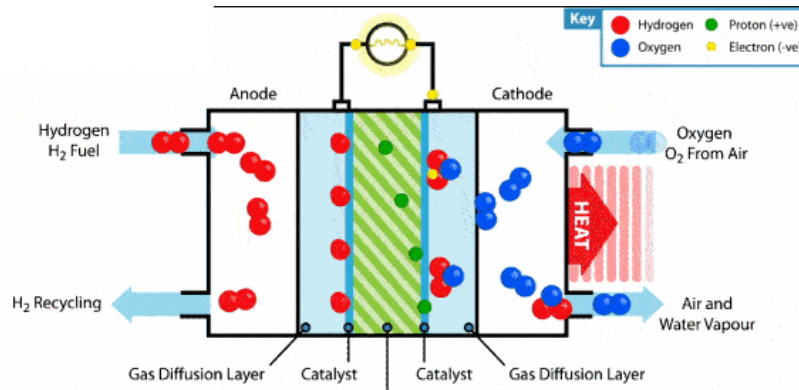

Figure 1. Operation of the PEM fuel cell [2]

## 2. RESEARCH SIGNIFICANCE

Basic information research about peltier; the concept of thermoelectric, which expresses the direct conversion of heat and electrical energy to each other, was first proposed by Thomas Johann Seebeck in the 19th century, but could not be developed sufficiently since it was not understood much in those days. Later, studies were carried out at the French Academy of Sciences on the effects of temperature differences at the junction between two different conductors. In 1834, French physicist Jean Charles Athanasa discovered that by passing DC current over two different semiconductor materials, heat motion was generated in the direction in which the current moves. This phenomenon is called the Peltier effect. When the direct current passes through the circuit, which is formed from two combined semiconductor materials, heat is absorbed from the junction with the Jolue heat and heat emerges from the other junction. The amount of heat released is directly proportional to the flow through the circuit [3]. Johann Seebeck, using two different metals in the electric circuit he created in the case of metals at different temperatures, observed that the system generates electric current. This event is known as the Seebeck event. This electrical voltage difference due to temperature difference is called the Seebeck effect. The electrical voltage generated between the metals depends on the magnitude of the temperature difference. Shown in the Figure 2. Thermoelectric structures can be examined under two headings as thermoelectric generators and coolers. Thermoelectric generators are structures that convert heat energy directly to electrical energy. Thermoelectric coolers are heat pumps that allow the transport of heat from the cold to the hot zone using electrical energy [4].

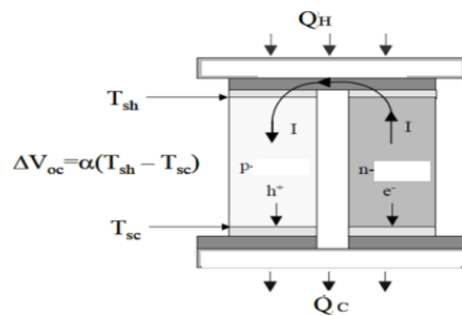

Figure 2. Electron mobility with temperature difference [5]

Basic information research about fuel cell; a fuel cell is a system that generates electrical energy by an electrochemical reaction of a suitable fuel and oxidizer. That is, the fuel cell is a generator that converts fuel chemical energy directly into electrical energy through the electrochemical reaction of fuel and air. After the fuel cell reaction, which can also be described as the reverse reaction of electrolysis, electricity is generated in the form of direct current (DC). Fuel cells are similar to cells and batteries in that they generate electricity through an electrochemical process. Cells and batteries convert the stored energy into electrical energy by an electrochemical reaction. The energy they provide is limited to the energy stored in it. Fuel cells, on the other hand, are energy production systems that can perform this transformation as long as fuel and air are supplied [5]. Figure 3 shows schematically a fuel cell and its operation.

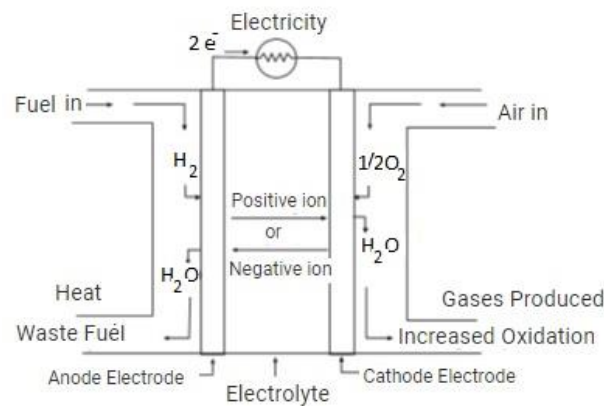

Figure 3. General structure and operation of a fuel cell [9]

### 3. EXPERIMENTAL METHOD

The experiments were carried out in laboratories of the Department of Energy Systems Engineering, Faculty of Technology, Batman University. In order to carry out the experiments, we drew upon the experimental setup installed by the Master's Degree students working with Fuel Cell. To measure the energies to be obtained on an experimental set prepared for the Fuel Cell, DC current-powered Ammeters and Voltmeters were installed. The ammeters installed in the existing system are shown in Figure 4. The measuring instruments that measure moisture and temperature installed in the input and output of Hydrogen and Oxygen used in fuel cell operation are shown in Figure 5. In the test apparatus installed, the peltier material was prepared for testing. While heating one surface of Peltier with the heat source, a fan was used to remove heat from the other surface. Experiments were

performed at different times by creating a temperature difference on the surfaces of the Peltier material. During the test, the surface temperatures were continuously measured and recorded, and the power obtained was calculated by looking at the voltage and current values corresponding to each temperature difference.



Figure 4. Peltier preparation

### 3.1. Experiments of Fuel Cell

As a result of the experiments, it was observed that the peltier was unresponsive to temperature differences below 50°C. Furthermore, as the temperature difference between the two surfaces increased, the change followed a course as in Figure 7. In the experiments, while surface temperatures of peltier were measured by thermometers, current and voltage values were measured by multimeter, and power was obtained by;

$$P=I*V \text{ correlation} \tag{1}$$

According to the open circuit voltage, if there is no loss in the fuel cell, the operations are reversed. According to this ideal case, reversible open circuit voltage is present. For each water molecule produced in a fuel cell and for each hydrogen molecule used, 2 electrons pass through the circuit. Thus used 1 mole 2N electron for hydrogen passes (N: Avagadro number) [6].

If the charge of an electron is;  
 $e (1.602 \times 10^{-19} \text{ Coulombs/electron})$  (2)

Total transferred load:  $-2Ne=-2F \text{ Coulombs}$  (3)

F is the faraday constant and its value is  $9.652 \times 10^4 \text{ coulomb/gm-}$   
mole (4)

E is the voltage of the fuel cell, electrical work:  
Electrical work=loadxvoltage= $-2FE \text{ Joules}$  (5)

If the system is reversible, the work will be equal to Gibbs free energy.

Gibbs free energy:  $\Delta gf=-2F \cdot E$  (6)

Open circuit voltage:  $E = \frac{\Delta gf}{-2F}$  (7)

Estimated maximum yield:= $\frac{\Delta gf}{\Delta hf} * 100$  (8)

we can make such identification [6].  
 $E = \frac{\Delta gf}{-2F} = \frac{237,340}{2.96,485} = 1.23 \text{ Volts}$  (9)

At 25°C and atmospheric pressure the theoretical H/O potential is 1.23 Volts for fuel cell [7].

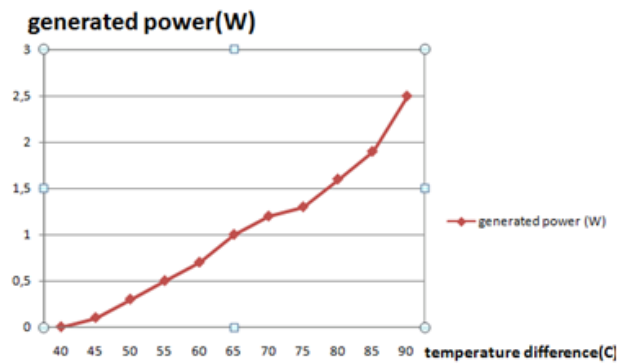

Figure 5. The power generated by the temperature difference of the Peltier

### 3.2. Running Fuel Cell and Thermoelectric Coolant Together

In order to integrate the peltier in the production stage of the fuel cell and to conduct heat well, an aluminum surface is required. The Peltier is attached to this side of the fuel cell. A fan was placed on the other surface. Hydrogen and Oxygen gases were introduced into the fuel cell and its fan was not turned on to increase its temperature over time. In 10 minutes, the fuel cell started to produce 6 volts and close to 1 amp. However, the temperature began to increase. The cooling fan of the fuel cell was not operated until the surface temperature reached 70°C. With the effect of the fan affixed to the peltier, the fuel cell warmed up later than before. But the heat passing through the peltier did not suffice to cool the fuel cell. For, after a while, the temperature started to rise above 75°C again. While this is desirable for the peltier, it significantly reduces the performance of the fuel cell. Figure 11 shows the simultaneous operation of the fuel cell and peltier. Shown in the Figure 6.

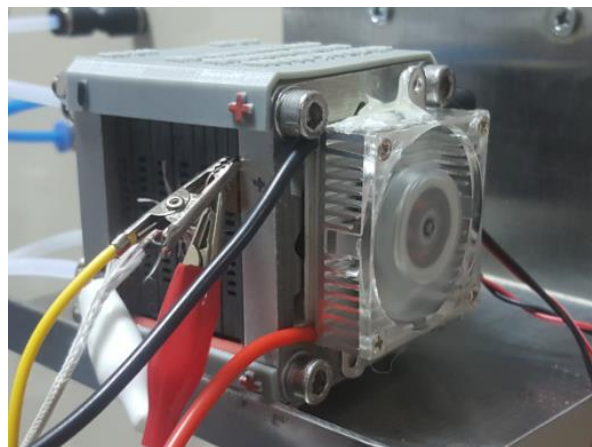

Figure 6. Designed Fuel Cell and Peltier Set

## 4. FINDINGS AND DISCUSSIONS

After taking the necessary precautions to the prepared apparatus, experiments were started by connecting hydrogen and oxygen cylinders. The performance of the fuel cell was tested by taking measurements according to flow and time parameters. First, the fuel cell was activated for a while to stabilize. Figures 8 and 9 were created with data from these experiments. A higher power curve was then obtained with the same flow rate. It was generated by the data

obtained in Figure 10 by operating the fuel cell after stabilization. As the data shows, the performance of our polymer membrane fuel cell starts to decrease after 70°C. In this case, when the fan of the fuel cell is activated, the temperature drops and the performance starts to rise again.

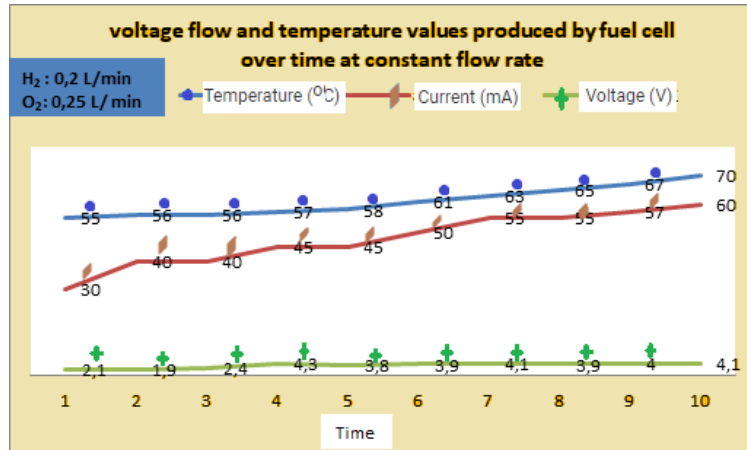

Figure 7. Voltage current and temperature values obtained from fuel cell under the flow rate of 0.2ml/min H<sub>2</sub> and 0.25ml/min O<sub>2</sub>

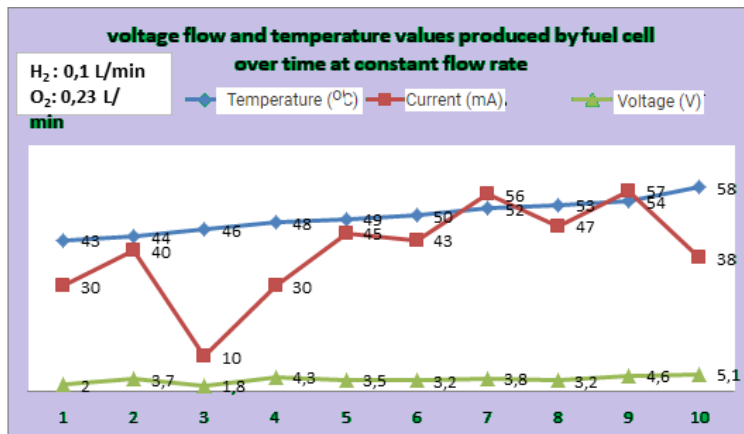

Figure 8 . Voltage current and temperature values obtained from fuel cell under the flow rate of 0.1ml/min H<sub>2</sub> and 0.23ml/min O<sub>2</sub>

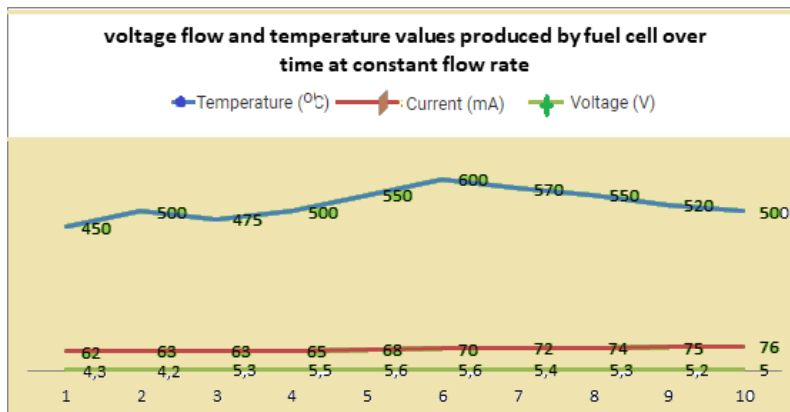

Figure 9. Voltage flow and temperature values obtained from the stable fuel cell at 0.1ml/min H<sub>2</sub> and 0.25ml/min O<sub>2</sub> flow rate

Experiments were performed at different time intervals. Experiments were repeated until the fuel cell stabilized. The system was operated for 3 days to stabilize the cell. On Day 3, both the fuel cell and the peltier were operated simultaneously and the values were taken. The values are converted into graphs as shown in Figure 7, 8, 9.

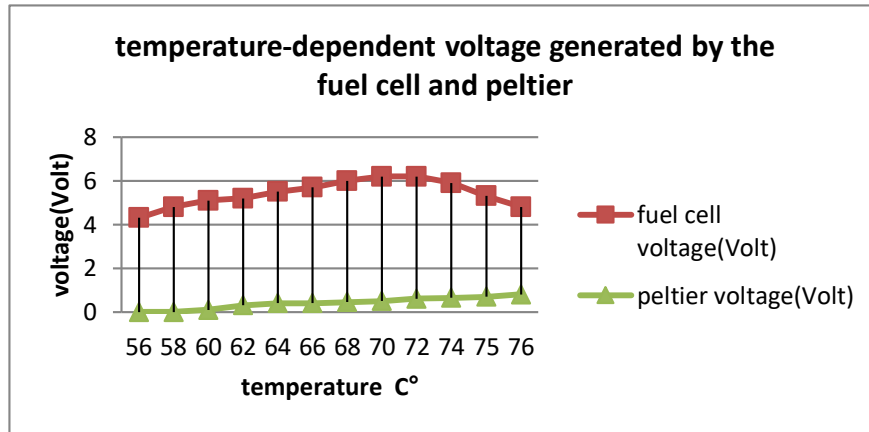

Figure 10. Voltage chart from Fuel Cell and Peltier

When the temperature of the fuel cell was at 72°C, a voltage of 6.1 volts and a current of 0.570 A produced a power of 3.47 watts. At the same time, a power of about 0.35 watts was obtained in the peltier material. This value obtained from peltier corresponds to 10% of the fuel cell. Although this percentage increases for increasing temperature values, there is a significant decrease in the performance of the fuel cell and therefore cannot compensate for the loss. The fuel cell has a very variable characteristic. Due to this variability, it is very difficult to obtain energy on a regular basis. The direct use of the resulting energy leads to irregularities. Therefore, the storage and subsequent use of the obtained energy will complete the deficiency of these irregularities. The main purpose here is to make energy with the fuel cell while making some contribution to this energy with peltier. The studies and calculations reveal this contribution. Shown in the Figure 10.

##### 5. CONCLUSION AND RECOMMENDATIONS

When the designed system is operated, the fuel cell generates waste heat while generating energy. This heat is also used in peltier material. Thus, both the fuel cell produces electric current and the peltier electric current. Thus, the efficiency of the obtained energy could be increased up to 10%. In this study, it was observed that Peltier remained unresponsive to surface temperature differences below 50°C. As the temperature difference between the surfaces of the peltier increases, the power obtained increases at that rate. It has been observed that the performance of polymer membrane fuel cells decreases at temperatures above 75°C. More efficient results will be obtained if phosphoric acid or solid oxide fuel cells operating at higher temperatures are preferred instead of polymer membrane fuel cells for such an operation. In the study, there was an increase in yield. As a result, it is recommended to test in fuel cells where the heat dissipated from the fuel cell is high. A different method of cooling the peltier (aqueous cooling) can be tried.



---

**NOTICE**

This study was carried out within the scope of TÜBİTAK 2209 and 2476 TL was supported for the supply of the materials.

**REFERENCES**

- [1] Enerji Raporu, (2015). Elektrik Mühendisleri Odası. İzmir, Turkey.
- [2] İçingür, Y. ve Kireç, L., (2011). Bir Polimer Elektrolit Membran Yakıt Piliinde Kullanılmak Üzere Gaz Akış Plakaları Tasarımı ve Denenmesi, *Politeknik Dergisi*, Ankara, Turkey.
- [3] Fidan, U., (2000). Mikro Denetleyici Kontrollü Taşınabilir Termoelektrik Tıp Kiti Cihazı Tasarımı ve Uygulanması. Ankara: Gazi Üni. Fen Bil. Enst. Yüksek Lisans Tezi, Turkey.
- [4] Richard, J., (1997). Buistand Paul G. Lau, Calculation of Thermo Electric Power Generation Performance Using Finite Element Analysis, *Proceedings of The Xvi International Conference On Thermoelectrics*, August 26-29, Dresden, Germany.
- [5] Yıldırım Y., (2011). Yakıt Pilleri Ders Notları, Zonguldak, Turkey.
- [6] Yılmaz, A., Ünvar, S., Şevik, S., and Demir, M., (2017). Usability in Vehicles of PEM Fuel Cells, 8th International Advanced Technologies Symposium (IATS'17), Elazığ, Turkey.
- [7] Sammes, N., (2005). Fuel Cell Technology-Reaching Towards Commercialization, *British Library Cataloguing in Publication Data*, Uk.